



Unit Illustrated: Model MCVST42NH See-Through Fireplace (Natural Gas), MST42GT Glass Tray, MQ65C Glass Media Bronze 1/2" (x5), MQ42LOG3 Driftwood Set, MQ42DD2BL Designer Door Series 2.

BENTLEY ST

ZERO CLEARANCE DIRECT VENT
SEE-THROUGH GAS FIREPLACE

 marquis
COLLECTION

TWO SIDES TO THIS STORY

With an expansive glass viewing area and clever designer options, we thought the Bentley was pure designer perfection. Now, we've introduced the see-through **Bentley ST by Marquis** which means you get the same view ... twice!

Being able to enjoy the beauty and warmth from both sides means we've doubled the reasons to love the **Bentley ST**.

Visit marquisfireplaces.net to see the latest evolution in fireplaces.

BENTLEY ST

STANDARD FEATURES

- Dedicated Clean View appliance
- Millivolt or IPI valve system allows operation during a power failure with Hi/Low heat and flame adjustment
- Safety Screen Barrier

OPTIONAL FEATURES

Fan Kit:

Heat activated with variable speed control

Designer Doors:

Three styles – Arch, Straight Black (2 options)

Surrounds:

Hearth Mount, Picture Frame, Slim Line Picture Frame

- Hearth Mount 4" Wide (Covers 44 5/8" W x 38 1/8" H)
- Picture Frame 4" Wide (Covers 44 5/8" W x 40 1/8" H)
- Picture Frame 1 5/8" Wide (Covers 40 1/8" W x 35 5/8" H)

Glass Tray:

Contemporary Rocks (2 options), Driftwood Set, Decorative Stones, Decorative Ember Glass (Glacier Ice, Cobalt Blue, Black, Bronze, White), Ember Chunks or Multi-Colored Cannonballs

Liners:

Porcelain Reflective or Traditional Brick

Accent Lighting:

For use with the Glass Tray

Log Sets:

Two Driftwood Sets (6 or 8 Piece), Two Oak Sets (7 or 8 Piece)

Remotes Controls:

Thermostat on/off, Thermostat on/off modulating, Thermostat on/off modulating and fan/light control

Thermostats:

Wall Mount or Programmable





Unit Illustrated: MCVST42NH See-Through Fireplace (Natural Gas), ZCV42S1PFBL Surround (Picture Frame 4" Wide), MST42GT Glass Tray, MQG5C Glass Media (Bronze x5), MST42PL Porcelain Liner.



BENTLEY ST VARIATIONS



Unit Illustrated: MCVST42NH See-Through Fireplace (Natural Gas), ZCV42S2PFBL Surround Picture Frame 1 3/4" Wide, MST42GT Glass Tray, MQG5C Glass Media (Bronze x5), RBCB1 Cannonballs, MST42PL Porcelain Liner.

BENTLEY ST PRODUCT SPECIFICATIONS

Model	MCVST42N/NE	MCVST42LP/LPE	MCVST42NH/NHE	MCVST42LPH/LPHE
Fuel	Natural	Propane	Natural	Propane
Gas Control	Millivolt / IPI	Millivolt / IPI	Millivolt / IPI	Millivolt / IPI
Input Max.	30,250 BTU	29,000 BTU	31,000 BTU	29,250 BTU
Input Min.	20,750 BTU	23,000 BTU	21,000 BTU	23,000 BTU
FE (P.4.1–15)	57.56% / 59.55%	58.56% / 55.32%	66.45% / 68.58%	67.88% / 70.36%
Glass Type	Tempered	Tempered	Ceramic	Ceramic



MCVST42NH See-Through Fireplace (Natural Gas), ZCV42S1BL Surround (Hearth Mount 4" Wide), MST42GT Glass Tray, MQG5C Glass Media (Bronze x5), MQROCK2 Rock Set (Contemporary Collection – Natural), MST42PL Porcelain Liner.



MCVST42NH See-Through Fireplace (Natural Gas), MST42GT Glass Tray, MQG5C Glass Media (Bronze x5), MQ42LOG1 Driftwood Log Set, MST42PL Porcelain Reflective Liner, ZCV42S1PFBL Surround (Picture Frame 4" Wide).



MCVST42NH See-Through Fireplace (Natural Gas), ZCV42S2PFBL Surround Picture Frame 1 5/8" Wide, MST42GT Glass Tray, MQG5ZG Glass Media (Zircon Ice x2), MST42PL Porcelain Liner.



MCVST42NH See-Through Fireplace (Natural Gas), ZCV42S1PFBL Surround (Picture Frame 4" Wide), MST42GT Glass Tray, MQG5ZG Glass Media (Zircon Ice x5), MST42PL Porcelain Liner.

Unit Illustrated: Model MCVST42NH See-Through
Fireplace (Natural Gas), MST42GT Glass Tray,
MQG5C Glass Media (Bronze x5), MQSTONE
Decorative Stones, MST42PL Porcelain Liner.



DIMENSIONS

MODEL	Height		Front Width		Depth	
	Actual	Framing	Actual	Framing	Actual	Framing
MCVST42	51 1/4"	51 3/8"	43 1/16"	43 1/8"	24 1/4"	23 1/16"

RIGHT FRONT FACE VIEW

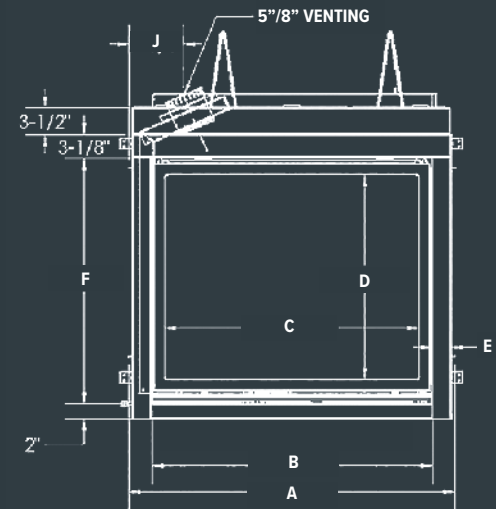

MCVST42

- A 43 1/16"
- B 37 1/16"
- C 33 11/16"
- D 27 3/16"
- E 2 1/2"
- F 32 1/2"
- G 2"
- H 3 1/8"
- I 3 1/2"
- J 7 1/4"
- K 23 1/8"
- L 24 1/4"
- M 24 1/4"
- N 51 1/4"
- O 42 7/8"

TOP VIEW

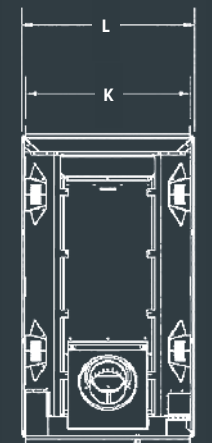

END VIEW

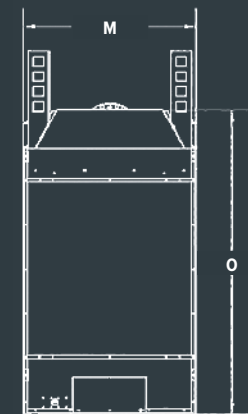

BENTLEY ST ACCESSORIES

LOG SETS



MQ42LOG4
8 Piece Oak
Log Set



MQ42LOG2
7 Piece Oak
Log Set



M42LOG3
6 Piece
Driftwood Set



MQ42LOG1
8 Piece
Driftwood Set

DESIGNER DOORS



DD1



DD2



DD3

MEDIA OPTIONS

REQUIRES GLASS SUPPORT PLATFORM (MQRSP8) OR ROCK SUPPORT PLATFORM (MQRSP4)

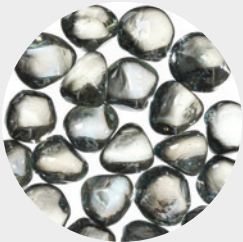

MQG5ZG
Zircon Glacier
Ice Glass

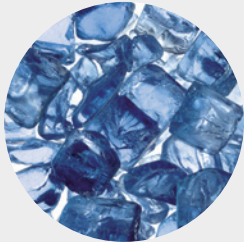

MQG5A
Cobalt
Ember Glass

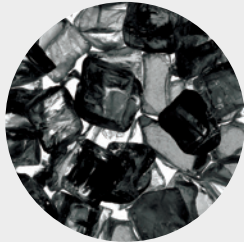

MQG5B
Black
Ember Glass



MQG5C
Bronze
Ember Glass

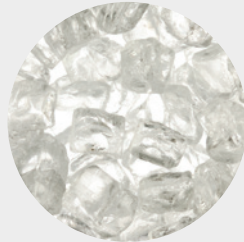

MQG5W
White
Ember Glass

WALL SURROUND



Black 4" Width



Black 1 5/8" Width



MQEMBER
Ember
Chunks



MQSTONE
Decorative
Stones



MQROCK2
Natural
Rock Set



MQROCK3
Multi-Colored
Rock Set



RBCB1
Multi-Colored
Cannonballs

LINERS

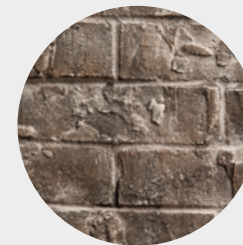

Traditional Brick



Porcelain Reflective



Unit Illustrated: Model MCVST42NH See-Through Fireplace (Natural Gas), M42LG Log Grate, MQ42LOG2 Oak Log Set, MST42RLT Traditional Brick Liner, MQ42DD2BL Designer Door Series 2.



Marquis Fireplaces maintains a program of continuous testing, refinement and improvements of all its products. Some aspect of units shown here may be changed at any time without notice or obligation.

Certification: These Models are certified to ANSI Z21.88-2017 CSA 2.33-2017 Vented Gas Fireplace Heaters.

Note: Components may have to be ordered separately to create a complete unit. Discuss with your local Marquis Dealer for clarification.

Canada

ENERGUIDE

Look for the **EnerGuide**
Gas Fireplace Energy
Efficiency Rating in this brochure

Based on CSA P.4.1-15



FOR CALIFORNIA RESIDENTS ONLY:
WARNING! This product can expose you to chemicals including Carbon Monoxide, that is an externally vented by-product of fuel consumption, which is [are] known to the State of California to cause birth defects or other reproductive harm. For more information, visit www.P65Warnings.ca.gov.

Crafted entirely in Canada, each Marquis fireplace is built to the highest standards and made to last.

LIMITED LIFETIME WARRANTY



2340 Logan Avenue
Winnipeg, Manitoba, CAN
R2R 2V3
Phone: 204.632.1962
Fax: 204.632.1960
marquisfireplaces.net

Printed in Canada
B083 - 11/2020