



NEXO USA

USER MANUAL (US)

LIST OF CONTENT

INTRODUCTION	4
Fire environmentally friendly	4
Recycling	4
Introduction to user manual	5
Safety and environmental testing	6
Warranty	6
U.S. Environmental Protection Agency	6
Convection	7
Glass and replacement of glass	7
Production number & Name tag	8
SPECIFICATIONS	9
DRAWINGS	10
TECHNICAL INFORMATION	20
INSTALLATION	22
Delivery packaging	22
Height adjustment	23
Installation of flue collar	24
Rear outlet	24
Precautions and specifications	25
Chimney	26
Chimney connector pass-throughs in combustible wall	28
Masonry chimney	30
Factory built chimney	31
Floor protection	32
Clearance to combustible walls	34
Clearance to non-combustible wall	36
Ventilation	36
Installation of swivel base	37



LIST OF CONTENT

FIREWOOD	38
Drying and storage	38
USING THE STOVE	39
Adjusting the combustion air	39
Carbon monoxide detectors	41
Control	41
First fire	41
Lighting and fueling	42
CARE AND MAINTENANCE	44
Fuel caution	44
Maintaining the installation	44
Care and maintenance	45
Removing the combustion chamber lining	46
Lubricating the hinges & lock	47
Cleaning the smoke/baffle system	48
Creosote - Formation and Need for Removal	50
Disposal of ashes	50
TROUBLE SHOOTING	51
SPARE PARTS	52
AIR KIT - FRESH AIR SUPPLY	54
Fresh air supply, air through the back	54
Fresh air supply, air through the bottom	55

Report no. : # 22-825
Revision : 2
Date (MDY) : January 23 / 2024

We cannot be held responsible for any misprints

FIRE ENVIRONMENTALLY FRIENDLY!

5 Eco-friendly advices for sensible heating
- common sense both environmentally and economically.

1. Effective lighting. Use small pieces of wood (fir tree) and a suitable fire lighter, for example paraffined wood wool/sawdust. Open the air damper, so plenty of air is fed to the stove and the gases from the heated wood can burn rapidly.
2. Light the fire with only little wood at a time - this gives the best combustion. Remember plenty of air for every time new wood is added.
3. When the flames are diminished, adjust the air damper so that the air supply is reduced.
4. When only glowing embers remain, air flow can be reduced further, so heating demand is just covered. With a lower air supply the charcoal will burn slower and the heat loss through the chimney is reduced.
5. Use only dry wood - ie. wood with a humidity of 15 to 20%.

RECYCLING:

The oven is wrapped in packaging that is recyclable. This must be disposed of according to national rules regarding the disposal of waste.

The glass can not be reused.

The glass should be discarded along with the residual waste from ceramics and porcelain.

Pyrex glass has a higher melting temperature and therefore can not be reused.

If discarded you make an important positive contribution to the environment.

INTRODUCTION TO THE USER MANUAL

Congratulations on the purchase of your new RAIS woodburning stove.

A RAIS woodburning stove is more than just a source of heat, it is a symbol of the emphasis you put on decorating your home with superiorly designed high-quality products.

PLEASE READ THIS ENTIRE MANUAL BEFORE YOU INSTALL AND USE YOUR NEW RAIS STOVE. FAILURE TO FOLLOW INSTRUCTIONS MAY RESULT IN PROPERTY DAMAGE, BODILY INJURY, OR EVEN DEATH. SAVE THIS MANUAL AND KEEP IT HANDY FOR EASY REFERRAL.

WARNING!

Do not use other, than the specified original Rais components.

Do not overfire. If the stovetop or chimney connector pipe glow red, you are overfiring



NOTE!

Do NOT install in transportable buildings.

Do NOT install the wood heater in a factory-built fireplace.

The wood heater is NOT to be installed in a structure constructed on skids or running gear.

Do NOT install in a mobile home.



IT IS RECOMMENDED TO USE SMOKE DETECTORS AND CARBON MONOXIDE DETECTORS WITH ANY HEARTH PRODUCT, INCLUDING THIS UNIT. FOLLOW ALL MANUFACTURER'S INSTRUCTIONS WHEN USING SMOKE AND CARBON MONOXIDE DETECTORS.

SAFETY AND ENVIRONMENTAL TESTING

The Stove is listed to **UL 1482-2022**, it is also EPA certified.

For future reference, please write down the production number of your RAIS wood-burning stove here. The number must be stated in all inquiries or complaints concerning this product.

Distributor: _____

Date: _____

Production number: _____
Produced by: RAIS A/S 9900 Frederikshavn, DK

WARRANTY

We offer a five-year warranty on your RAIS stove. The warranty covers any defects in materials or workmanship. However, it does not cover damage from misuse or neglect, and the glass, gaskets and firebricks are not covered either. Warranties are void if the unit is used to burn any materials other than wood or not operated in accordance with this owner's manual

U.S. ENVIRONMENTAL PROTECTION AGENCY

Certified to comply with 2020 particulate emission standards using crib wood.
1,1 g/hr, Method 28R

This wood heater needs periodic inspection and repair for proper operation. It is against federal regulations to operate this wood heater in a manner inconsistent with operating instructions in this manual.

This wood heater has a manufacturer-set minimum low burn rate that must not be altered. It is against federal regulations to alter this setting or otherwise operate this wood heater in a manner inconsistent with operating instructions in this manual.

CONVECTION

All RAIS stoves are convection stoves, which means that the sides of the stove never get too hot. Convection works by pulling cold air into the system at the base of the stove and up through the convection duct that is located along the combustion chamber of the stove. The heated air is released from the top of the stove, creating rapid air circulation in the room.

GLASS AND REPLACEMENT OF GLASS

All RAIS stoves supplied with Robax® glass in the door. Robax® glass is a ceramic glass type suitable for stoves. The glass is installed from RAIS as an integral part of the door and stove.

Inspect the glass for cracks prior to the first fire.

WARNING!

Do not use the stove if the glass is broken - contact your local authorized dealer.



NOTE!

Abuse may cause damage to the glass and door.

Do NOT strike the door or glass nor slam the door

Do NOT build the fire close to the glass or opening.



In case of broken glass during use of stove - let the stove slowly burn the remaining firewood under supervision. Do not close the chimney baffle if installed. Contact your local authorized dealer

The glass is supplied as an integral part of the door for spare part. The Robax® glass may only be replaced by genuine spare parts from RAIS. Do not use substitute material. Replacement of the glass as separate component is only for authorized personnel.

PRODUCTION NUMBER

The production number can be found on the back of the stove.

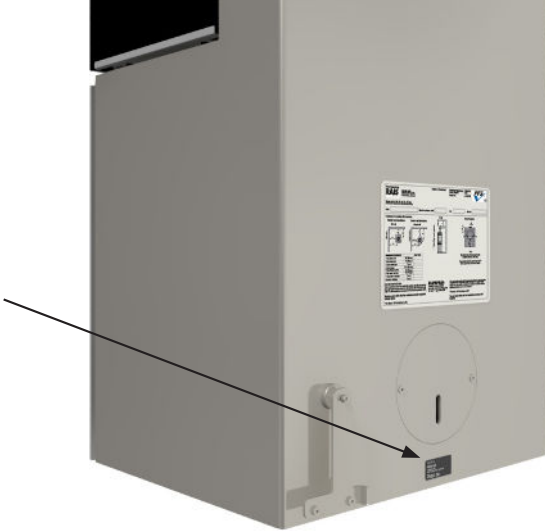

NAME TAG

The name tag can be found on the back of the stove.

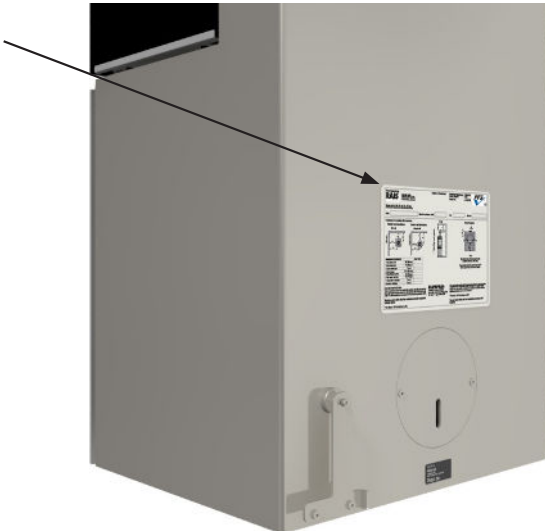

US

SPECIFICATIONS

	Nexo 100 USA	Nexo 120 USA	Nexo 140 USA	Nexo 160 USA	Nexo 185 USA
Weight of Stove	App. 293 lbs (133kg) 176-16.7-40.4" 446-398-1025mm	App. 328 lbs (149kg) 176-16.7-48.6" 446-398-1235mm	App. 362 lbs (164kg) 176-16.7-56.1" 446-398-1425mm	App. 384 lbs (174kg) 176-16.7-62.9" 446-398-1600mm	App. 415 lbs (188kg) 176-16.7-73.2" 446-398-1860mm
Stove exterior: Width/depth/height	13.9-11.5-176" 352-292-446mm	13.9-11.5-176" 352-292-446mm	13.9-11.5-176" 352-292-446mm	13.9-11.5-176" 352-292-446mm	13.9-11.5-176" 352-292-446mm
Firebox interior:Width/depth/height	110 m ² / 1184 sq.ft	110 m ² / 1184 sq.ft	110 m ² / 1184 sq.ft	110 m ² / 1184 sq.ft	110 m ² / 1184 sq.ft
Heating capacity at -20°C/-4°F App.	1.4(kg) / 3(lbs)	1.4(kg) / 3(lbs)	1.4(kg) / 3(lbs)	1.4(kg) / 3(lbs)	1.4(kg) / 3(lbs)
Recommended amount of wood when fueling (kg) wood: 2-3 logs of wood of app. 25-33cm	49 minutes.	49 minutes.	49 minutes.	49 minutes.	49 minutes.
Intermittent operation: Refuelling should be undertaken within	268°C / 514°F	268°C / 514°F	268°C / 514°F	268°C / 514°F	268°C / 514°F
Flue gas temperature:	6" (15 cm)	6" (15 cm)	6" (15 cm)	6" (15 cm)	6" (15 cm)
Single wall connector stove pipe:	6" (15 cm)	6" (15 cm)	6" (15 cm)	6" (15 cm)	6" (15 cm)
Chimney pipe - class A, UL-103 HT:	7 - 31 kBTU (2 - 9kW)	7 - 31 kBTU (2 - 9kW)	7 - 31 kBTU (2 - 9kW)	7 - 31 kBTU (2 - 9kW)	7 - 31 kBTU (2 - 9kW)
Min./Max. output (kW):	0.048"WC (-12 Pa)	0.048"WC (-12 Pa)	0.048"WC (-12 Pa)	0.048"WC (-12 Pa)	0.048"WC (-12 Pa)
Minimum stove draft pressure at above output:	1,1 g/hr	1,1 g/hr	1,1 g/hr	1,1 g/hr	1,1 g/hr
Tested EPA emission particulate rate:	2,1 g/min.	2,1 g/min.	2,1 g/min.	2,1 g/min.	2,1 g/min.
CO emissions	72 %	72 %	72 %	72 %	72 %
Efficiency	13-19 kBTU	13-19 kBTU	13-19 kBTU	13-19 kBTU	13-19 kBTU
Min/Max thermal output					

NEXO 100 USA
Dimensional sketch

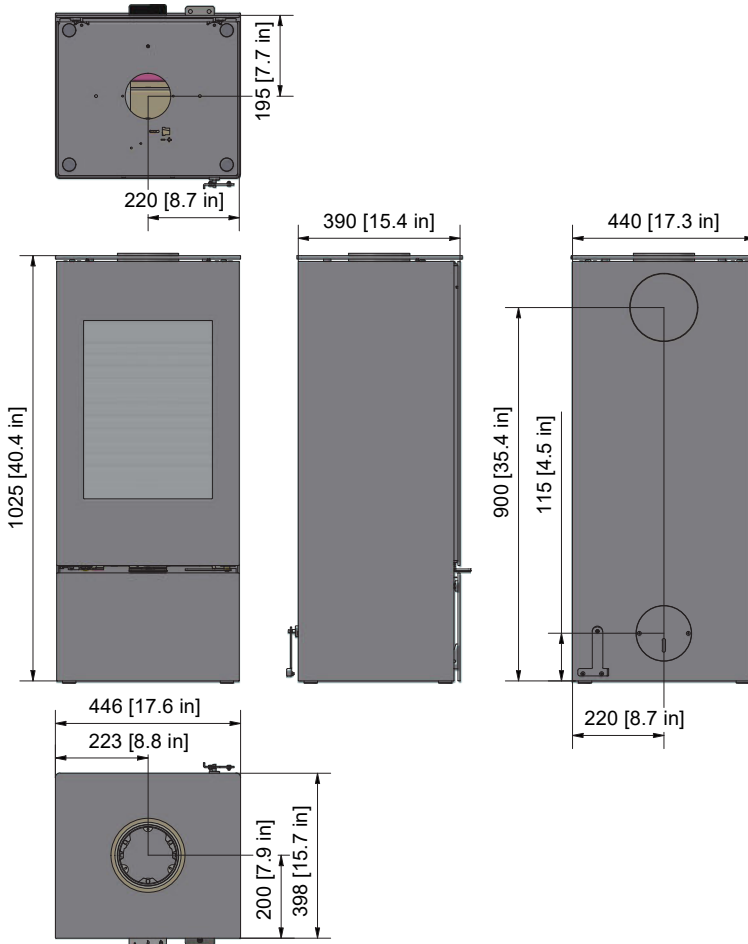

NEXO 100 USA - with side window

Dimensional sketch

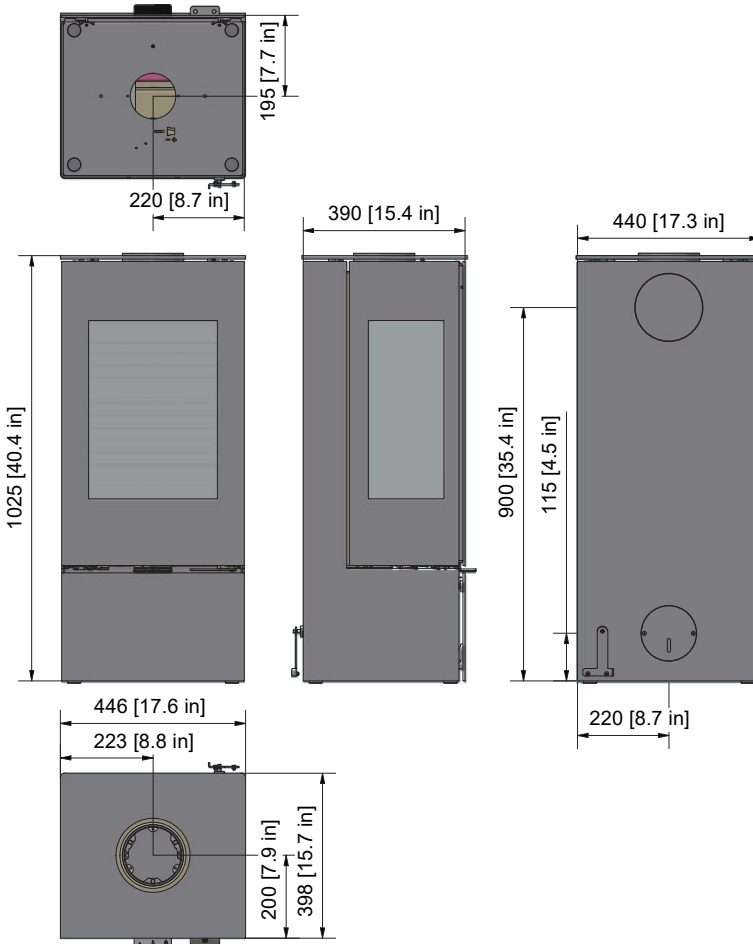

NEXO 120 USA

Dimensional sketch

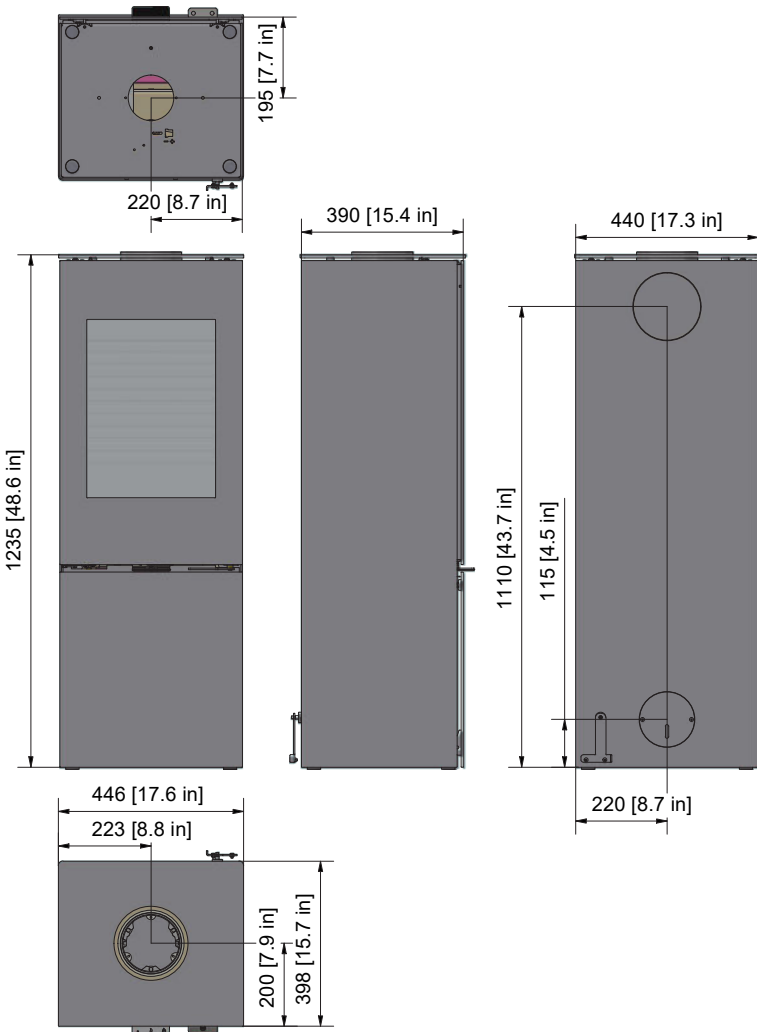

NEXO 120 USA - with side window

Dimensional sketch

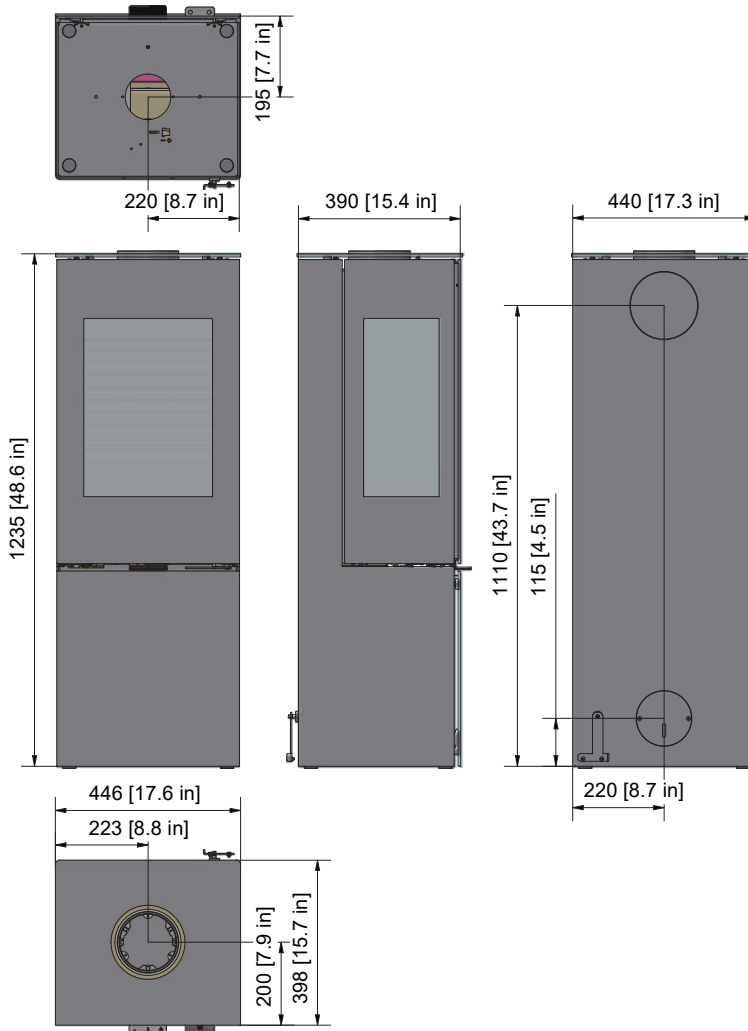

NEXO 140 USA

Dimensional sketch

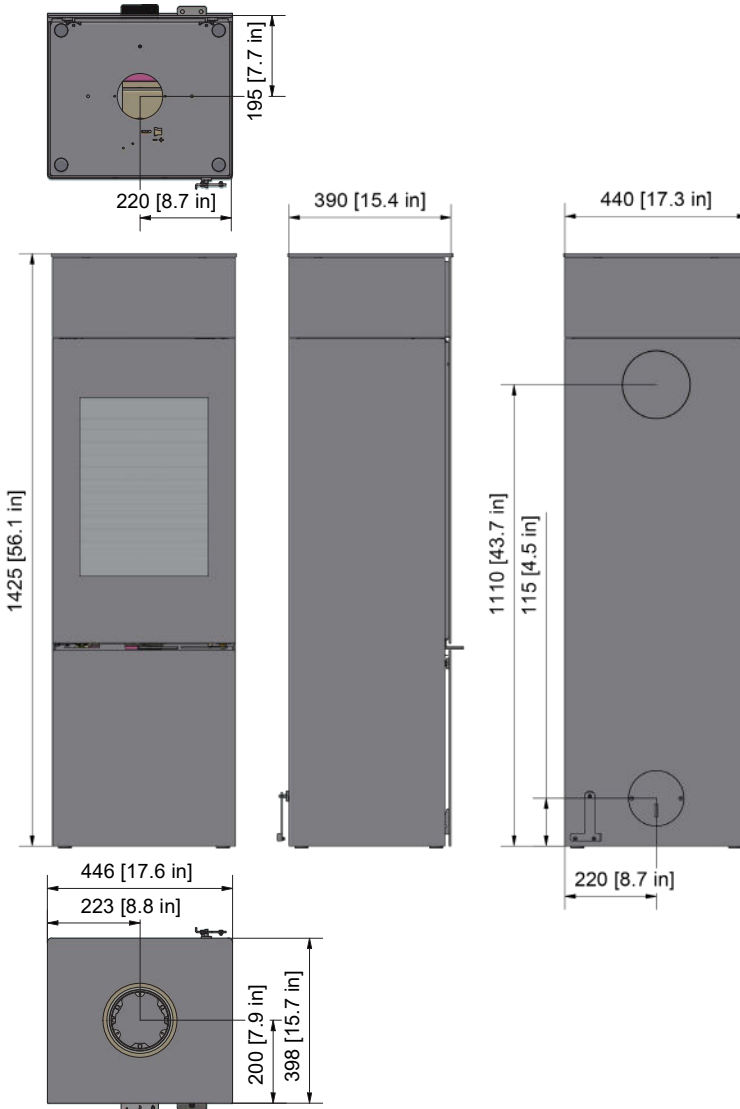

NEXO 140 USA - with side window

Dimensional sketch

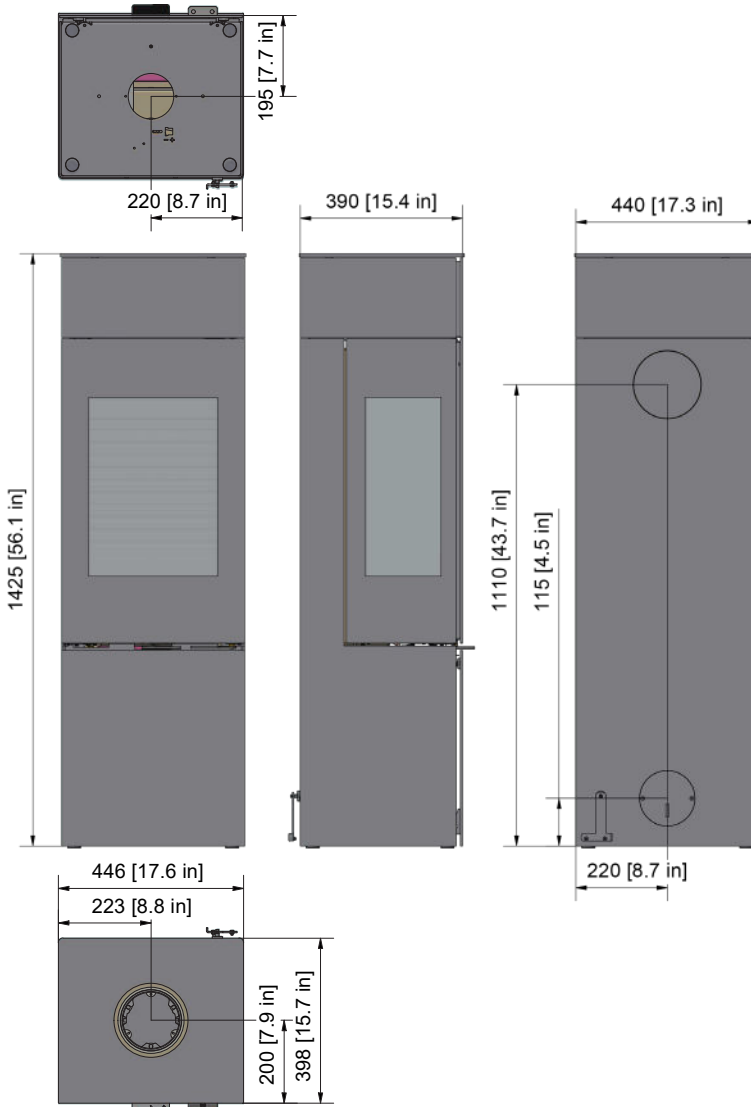

NEXO 160 USA

Dimensional sketch

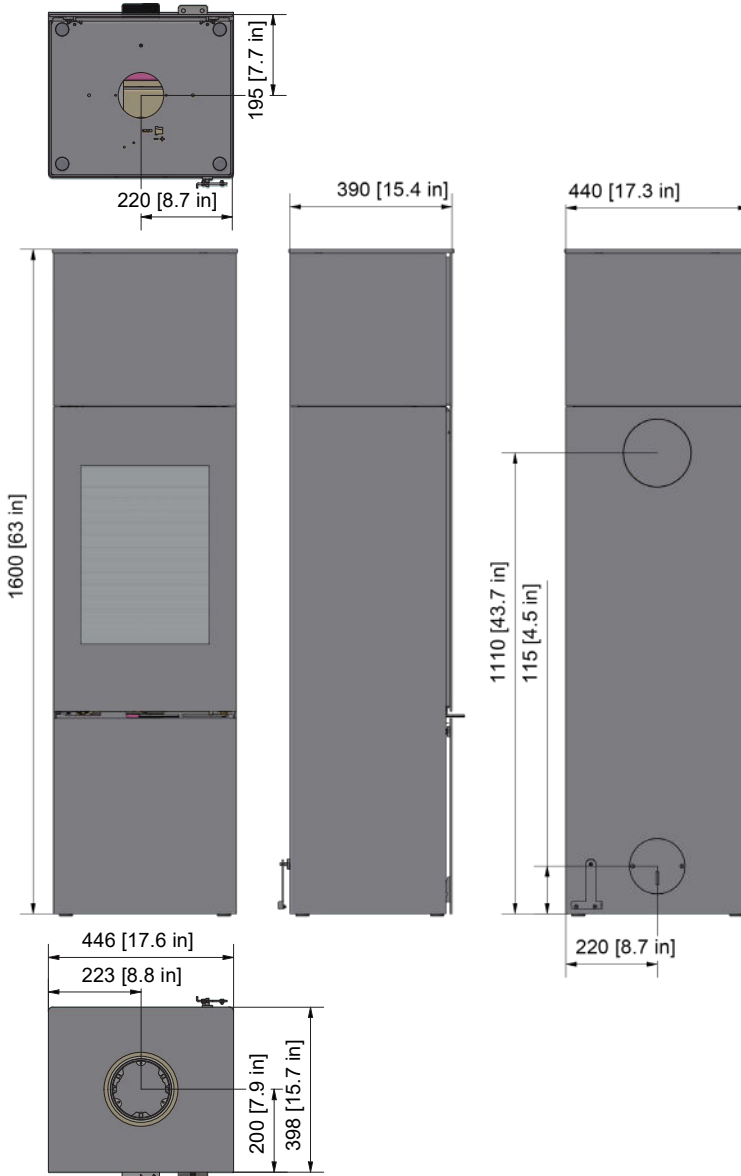

NEXO 160 USA - with side window

Dimensional sketch

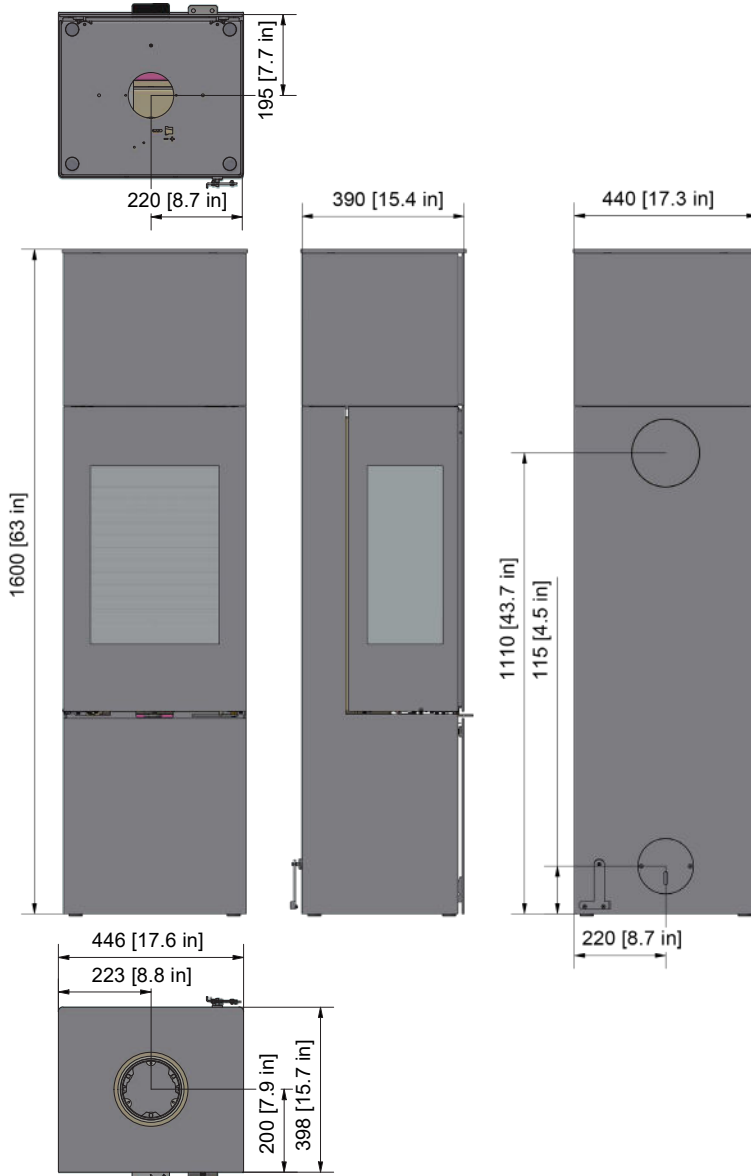

NEXO 185 USA

Dimensional sketch

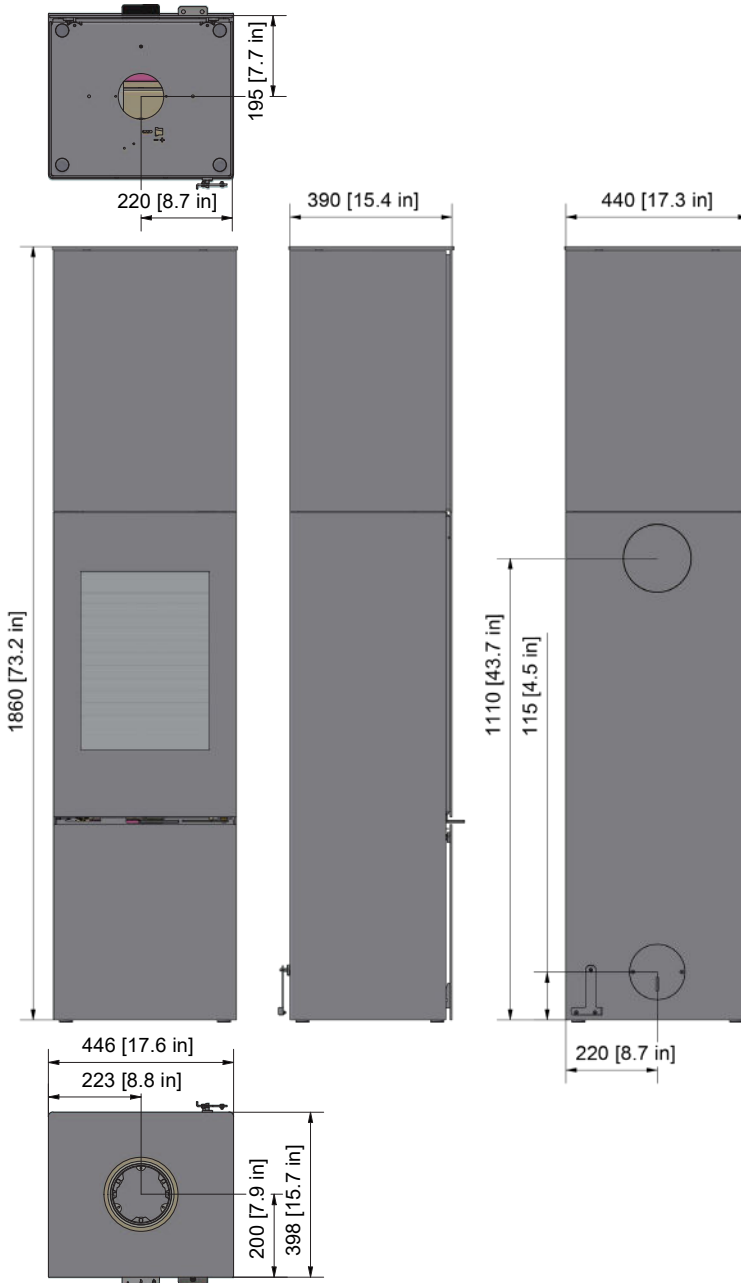

NEXO 185 USA - with side window

Dimensional sketch

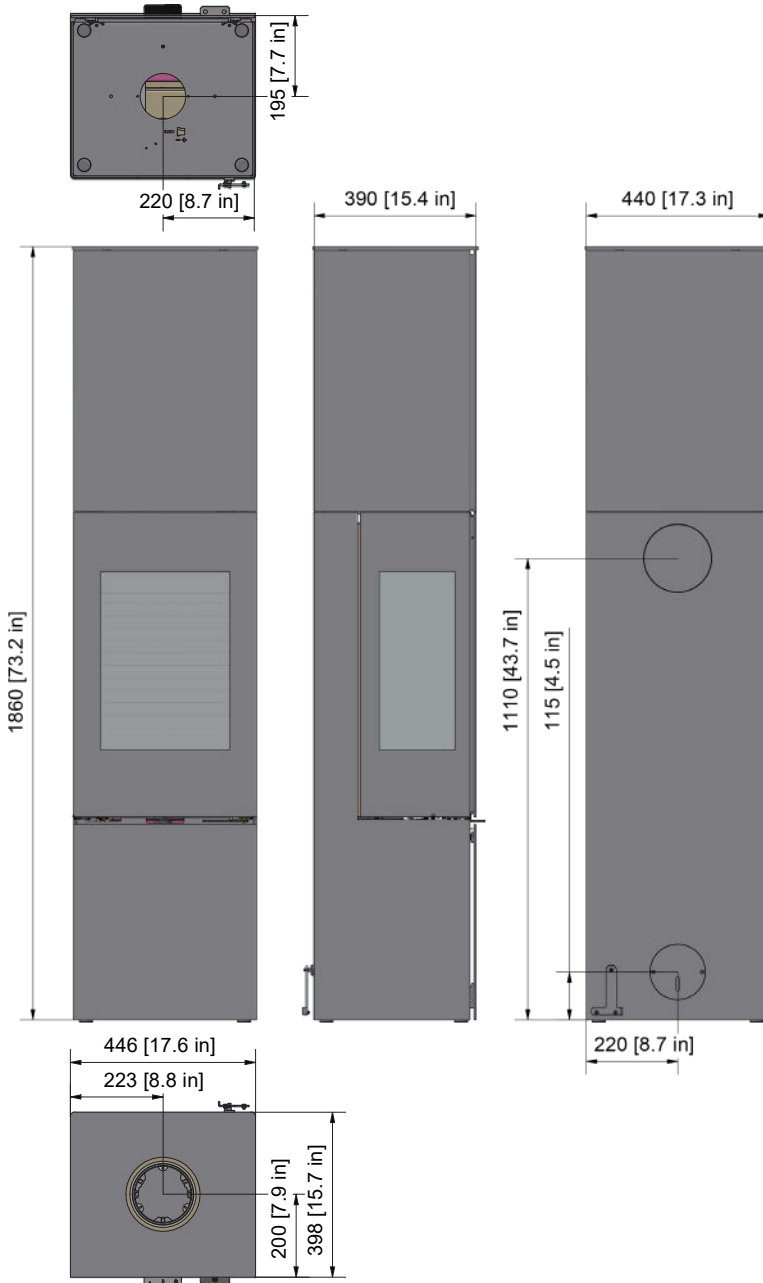

SO

TECHNICAL INFORMATION

Manufactured by:



RAIS A/S
 Industrivej 20, DK-9900
 Frederikshavn, Denmark

Model: NEXO 100, 140, 160, 185 USA
 Solid Fuel Room Heater, For Use With Solid Wood Fuel Only

Made in Denmark

Emission Report no.: 0138WS017E
Safety Report: 23-204
Tested to: UL 1482-2022



Model Date of manufacture Month Year Serial no.

Clearances to combustible surfaces

Parallel wall installation

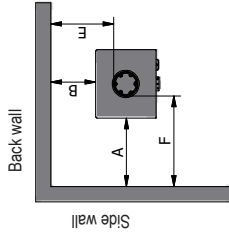

Corner wall installation

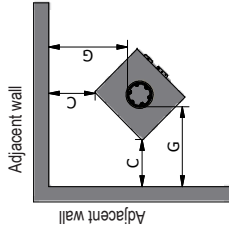

MINIMUM CLEARANCE	Rear Vent
A: Side Wall to Unit	20" (508 mm)
B: Back Wall to Unit	9" (229 mm)
C: Corner Wall to Unit	11" (279 mm)
D: Ceiling Height	56" (1422 mm)
E: Back Wall to Vent Pipe	13.7" (349 mm)
F: Side Wall to Vent Pipe	25.7" (653 mm)
G: Corner Wall to Vent Pipe	19.2" (486 mm)
Front Wall - Furnishing	36" (915 mm)

FLOOR PROTECTION:

Floor protection must be non-combustible material extending beneath the stove, and to the front and sides from door opening and to the rear as indicated. The floor protection is not required to have thermal protection (R=0)

Replace glass with only Rais authorized dealer supplied ceramic glass

** Not Tested - NFPA Guidelines in USA.

Ceiling

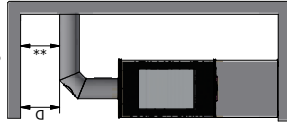

** Rear/Top vent option

Floor Protector

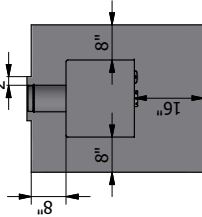

Front

See further floor protection requirements at bottom left corner of this label.

Floor protector must be under the pipe and 2" (5cm) beyond each side for back venting.

U.S. ENVIRONMENTAL PROTECTION AGENCY
 Certified to comply with 2020 particulate emission standards using crib wood. 1.1 g/hr, Method 28R

This wood heater needs periodic inspection and repair for proper operation. Consult the owner's manual for further information. It is against federal regulations to operate this wood heater in a manner inconsistent with the operating instructions in the owner's manual.

** Non testé - NFPA Guidelines au USA

The appliance must not be installed in a factory-built fireplace.

TO PREVENT HOUSE FIRES

Contact local Building or Fire officials about restrictions and installation inspection in your area.

Install and use only in accordance with manufacture's installation and operating instructions and local codes. In absence of any local codes, installation must meet minimum requirements of NFPA 221 in USA.

Refer to manufacture's instruction and local codes for precautions required for passing chimney through a combustible wall or ceiling. Inspect and clean chimney system frequently in accordance with manufacture's instruction.

Do not connect this stove to a chimney flue serving another appliance.

Do not use grate or elevate fire. Build wood fire directly on hearth.

Flue connector pipe must be 6 inch diameter, minimum single wall 24 msg black or 25 msg blued steel.

Chimney must be factory built 6" diameter Class "A" 103HT, or masonry.

TO PREVENT CREOSOTE FIRES

Inspect and clean chimney frequently - Under certain conditions of use, creosote buildup may occur rapidly.

Do not use other fuels than Fire wood.

CAUTION: Fully open combustion air control before opening the fuel feed door.

CAUTION: Only operate the wood heater with the doors closed.



CAUTION:

HOT WHILE IN OPERATION - DO NOT TOUCH. KEEP CHILDREN AND CLOTHING AWAY - CONTACT MAY CAUSE SKIN BURNS. SEE NAMEPLATE AND INSTRUCTIONS. KEEP FURNISHINGS AND OTHER COMBUSTIBLE MATERIALS A CONSIDERABLE DISTANCE AWAY FROM THE APPLIANCE.

Do not overfire - if heater or chimney connector glows, you are overfiring.

DO NOT REMOVE THIS LABEL

DELIVERY PACKAGING

Upon delivery, the stove is secured to a transport pallet using four transport safety fittings, one in each corner (A). The safety fittings are secured with screws, which must be unscrewed. The safety fittings can then be removed (B).

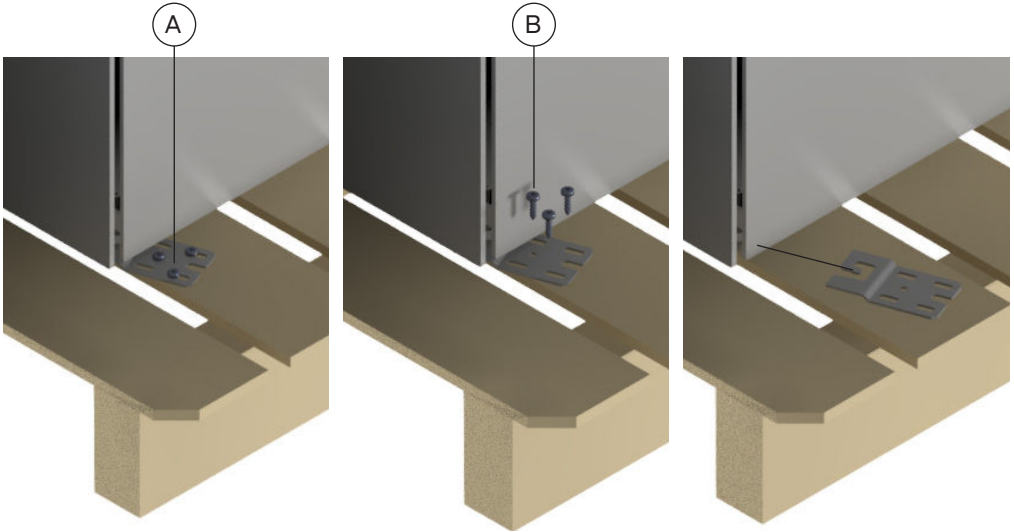

Transport securement of the baffle plate

The baffle plate is secured for transport, remove the securement before starting a fire in the stove.

HEIGHT ADJUSTMENT

The stove is equipped with four adjustment screws under the stove. Use the adjustment screws to ensure the wood-burning stove stands level.

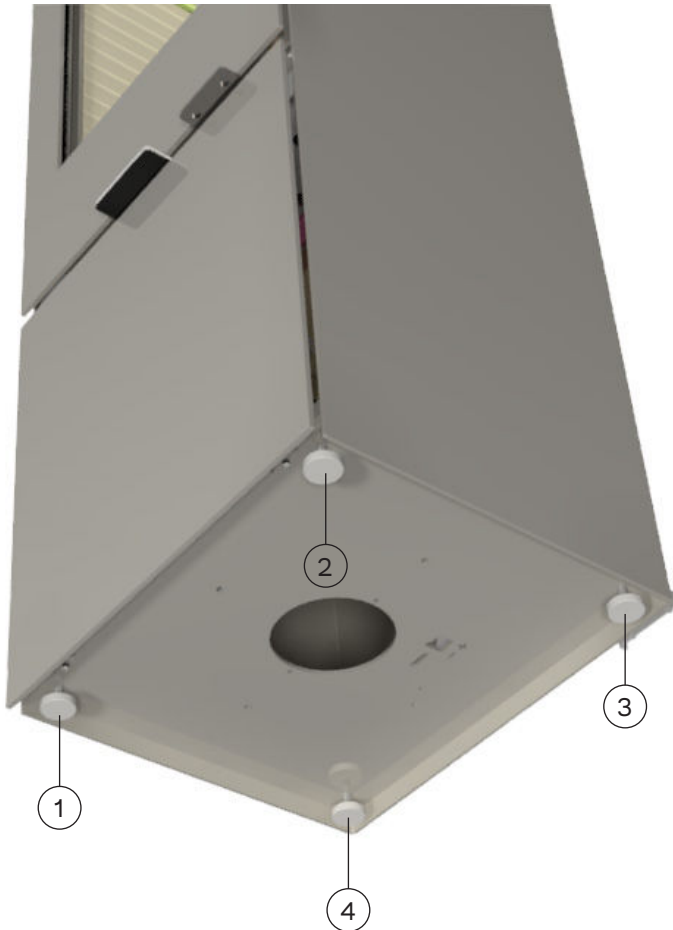

INSTALLATION OF FLUE COLLAR

The stove is prepared for top outlet on delivery. Mount the flue collar (61-110) with the delivered M6 nuts and bolts.



REAR OUTLET

The stove can be changed to rear outlet in the following way.

1. On the back of the stove there is a knock-out form that must be knocked free of the back. It is attached via four small pins.
2. Remove the knock-out form with a hammer or similar.
3. Remove the cover (1) and gasket (2) from the rear outlet and mount it on the top outlet.
4. Mount the smoke connection (3) on the rear exit.

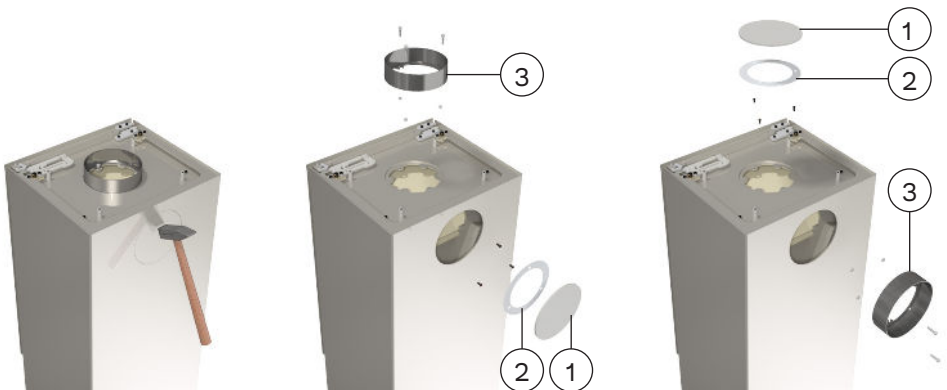

PRECAUTIONS AND SPECIFICATIONS

Before installation, remember to consult your local building inspector or fire marshal to determine the need to obtain a permit. Also enquire about restrictions and installation inspection requirements in your area. If utilizing an existing chimney, it is recommended that a professional mason or stove installer do a complete check-up of the chimney, liner, and flue beforehand.

In order for the stove to work and draw properly, sufficient air supply is important. Be especially aware of any mechanical fans (e.g. kitchen or bathroom exhaust systems) that may affect the proper draw.

WARNING!



If this stove is not installed properly, a home fire may result. To reduce this risk, please follow the directions for installation carefully.

NOTE!



Do NOT use grates, andirons, or other fuel support methods. Build fire directly on hearth.

CHIMNEY

RAIS stoves must be installed using a Class A UL 103 HT approved factory-built chimney system or a code-approved masonry chimney with a flue liner. The chimney pipe must be 6" in diameter.

The chimney must extend through the roof at least 3' (1m), and 2' (.6m) above any structure within 10' (3m). The condition and height of the chimney are very important for optimal use of the stove and we recommend a total minimum height of 10' (3m).

Note the chimney connector pipe should not pass through an attic, roof space, closet, concealed space, floor or ceiling.



NOTE!

Do NOT connect this stove to a chimney flue or air distribution duct or any system serving another appliance.

Never make "make-shift" compromises when installing the heater or chimney. chimney connector should be in good condition and kept clean.

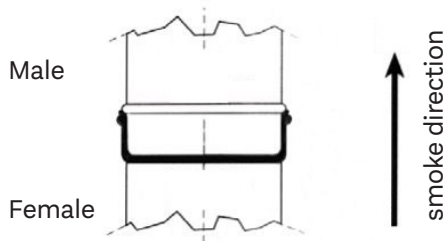

Each chimney connector or stove pipe section, must be installed to each other with the crimped end toward the stove. This prevents any amount of condensed or liquid creosote from running down the outside of the pipe or the stove top.

Fasten the connector pipe to the flue collar with 3 self tapping/drilling screws through the holes in the flue collar.

INSTALLATION

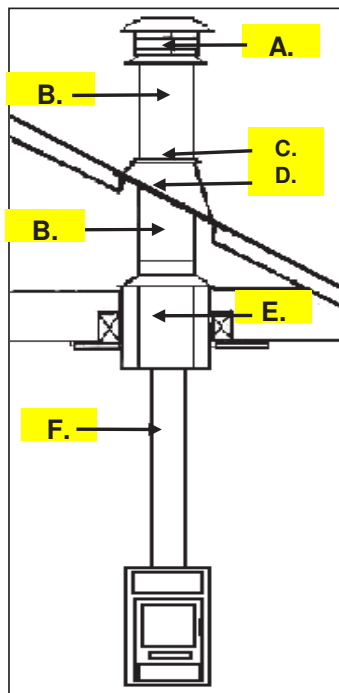

Required Installation Components:

- A. Chimney Cap
- B. Insulated Chimney
- C. Storm Collar
- D. Roof Flashing
- E. Ceiling Support Box or Joist Shield/Firestop Spacer
- F. Chimney Connector

For venting vertically into a Class A chimney, a single wall pipe (at least 24 gauge) may be used in the room where the stove is installed. Refer to the manufacturer's instructions for the connection to the listed chimney. The chimney/stove pipe must not be smaller than 6" (15cm) in diameter.

For venting directly into a masonry chimney or through a thimble, the top of the single wall pipe must be at least 18" (46cm) below a combustible ceiling and must conform to NFPA 211 guidelines and methods. Please see the diagram to the left.

For rear venting or other unlisted configurations, consult the local building codes and follow the NFPA 211 guidelines.

If the stovepipe is fitted with a baffle, it must be manually operated, visibly placed for ease of use, and must not close completely. Consult your chimney expert if you have any questions.

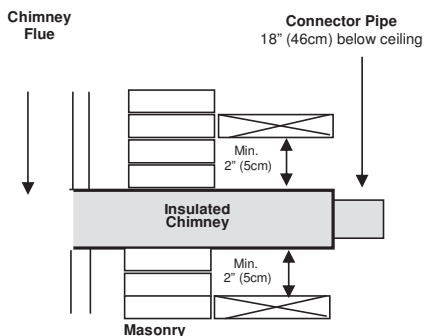

NOTE!

Please ensure that there is easy access to the chimney cleanout door.



CHIMNEY CONNECTOR PASS-THROUGHS IN COMBUSTIBLE WALL

Method A:

12" (304.8 mm) Clearance to Combustible Wall Member: Using a minimum thickness 3.5" (89 mm) brick and a 5/8" (15.9 mm) minimum wall thickness clay liner, construct a wall pass-through. The clay liner must conform to ASTM C315 (Standard Specification for Clay Fire Linings) or its equivalent. Keep a minimum of 12" (304.8 mm) of brick masonry between the clay liner and wall combustibles. The clay liner shall run from the brick masonry outer surface to the inner surface of the chimney flue liner but not past the inner surface. Firmly grout or cement the clay liner in place to the chimney flue liner.

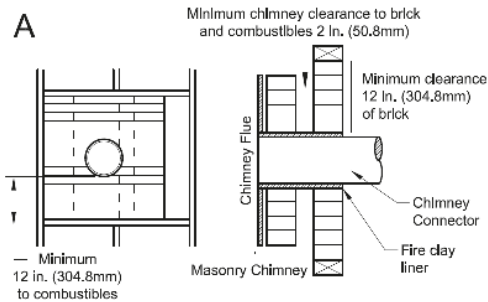

Method B:

9" (228.6 mm) Clearance to Combustible Wall Member: Using a 6" (152.4 mm) inside diameter, listed, factory-built Solid-Pak chimney section with insulation of 1" (25.4 mm) or more, build a wall pass-through with a minimum 9" (228.6 mm) air space between the outer wall of the chimney length and wall combustibles. Use sheet metal supports fastened securely to wall surfaces on all sides, to maintain the 9" (228.6mm) air space. When fastening supports to chimney length, do not penetrate the chimney liner (the inside wall of the Solid-Pak chimney). The inner end of the Solid-Pak chimney section shall be flush with the inside of the masonry chimney flue and sealed with a non-water-soluble refractory cement. Use this cement to also seal to the brick masonry penetration.

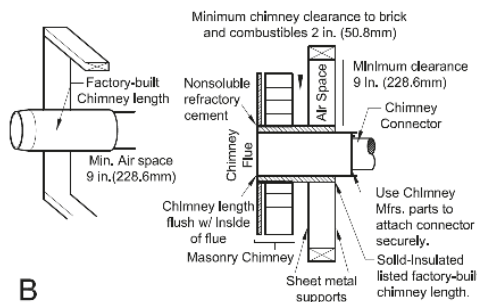

INSTALLATION

Method C:

6" (152.4 mm) Clearance to Combustible Wall Member: Starting with a minimum 24 gage (.024" [0.61 mm]) 6" (152.4 mm) metal chimney connector, and a minimum 24 gage ventilated wall thimble which has two air channels of 1" (25.4 mm) each, construct a wall pass-through. There shall be a minimum 6" (152.4 mm) separation area containing fiberglass insulation, from the outer surface of the wall thimble to wall combustibles. Support the wall thimble and cover its opening with a 24-gage minimum sheet metal support. Maintain the 6" (152.4 mm) space. There should also be a support sized to fit and hold the metal chimney connector. See that the supports are fastened securely to wall surfaces on all sides. Make sure fasteners used to secure the metal chimney connector do not penetrate chimney flue liner.

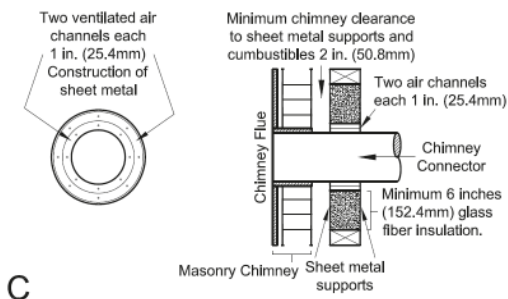

C

Method D:

2" (50.8 mm) Clearance to Combustible Wall Member: Start with a solid-pak listed factory built chimney section at least 12" (304 mm) long, with insulation of 1" (25.4 mm) or more, and an inside diameter of 8" (2 inches [51 mm] larger than the 6" [152.4 mm] chimney connector). Use this as a pass-through for a minimum 24-gauge single wall steel chimney connector. Keep solid-pak section concentric with and spaced 1" (25.4 mm) off the chimney connector by way of sheet metal support plates at both ends of chimney section. Cover opening with and support chimney section on both sides with 24 gage minimum sheet metal supports. See that the supports are fastened securely to wall surfaces on all sides. Make sure fasteners used to secure chimney flue line.

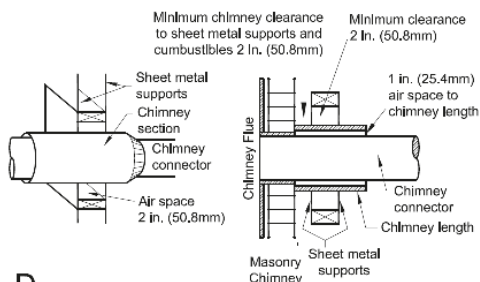

D

MASONRY CHIMNEY

Ensure that a masonry chimney meets the minimum standards of the National Fire Protection Association (NFPA) by having it inspected by a professional. Make sure there are no cracks, loose mortar or other signs of deterioration and blockage. Have the chimney cleaned before the stove is installed and operated. When connecting the stove through a combustible wall to a masonry chimney, special methods are needed.

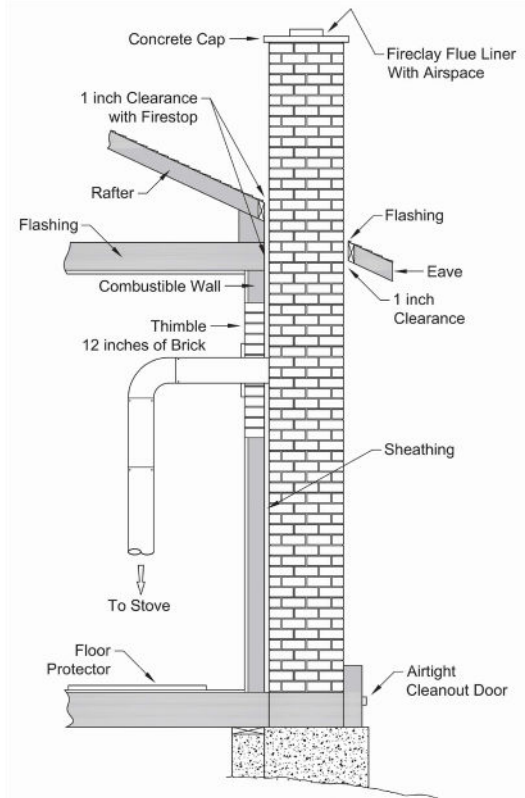

NOTE!

1. Connectors to a masonry chimney, excepting method B, shall extend in one continuous section through the wall pass-through system and the chimney wall, to but not past the inner flue liner face.
2. A chimney connector shall not pass through an attic or roof space, closet or similar concealed space, or a floor, or ceiling.



FACTORY BUILT CHIMNEY

When a metal prefabricated chimney is used, the manufacturer's installations must be followed. You must also purchase (from the same manufacturer) and install the ceiling support package or wall pass-through and "T" section package, firestops (where needed), insulation shield, roof flashing, chimney cap, etc. Maintain proper clearance to the structure as recommended by the manufacturer. The chimney must be the required height above the roof or other obstructions for safety and proper draft operation.

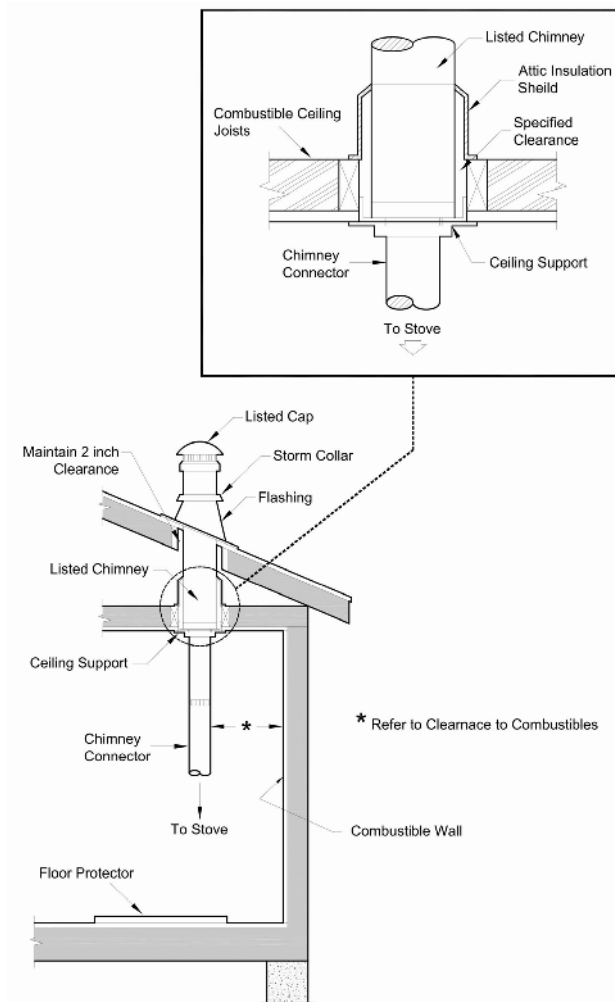

FLOOR PROTECTION

Alternate materials may be rated with C-factor (Thermal Conductance) or k-factor (Thermal Conductivity) ratings which must be converted to R-value to determine if the alternate material meets the tested requirements. The following instructions provide the proper information and formulas for conversion to R-value.

To determine if alternate materials are acceptable follow this sequence.

1. Convert material specifications to R-value.
 - a. R-value given – no conversion necessary.
 - b. K-factor is given with a required thickness (T) in inches: $R = 1/k \times T$
 - c. C-factor is given: $R = 1/C$

2. Determine the R-value of proposed alternate floor protector:
 - a. Use formulas in step 1 above to calculate R-value of proposed material(s).
 - b. For multiple layers, add R-values of each layer to determine overall R-value.

3. If the overall R-value of the floor protector system is equal to or greater than the floor protector specifications given, the alternate is acceptable.

Definitions:

$$\text{Thermal conductance (C)} = \frac{\text{BTU}}{(\text{hr})(\text{ft}^2)(\text{°F})} = \frac{\text{W}}{(\text{m}^2)(\text{°K})}$$

$$\text{Thermal conductivity (k)} = \frac{(\text{Btu})(\text{inch})}{(\text{hr})(\text{ft}^2)(\text{°F})} = \frac{\text{W}}{(\text{m})(\text{°K})} = \frac{\text{Btu}}{(\text{hr})(\text{ft})(\text{°F})}$$

$$\text{Thermal resistance (R)} = \frac{(\text{ft}^2)(\text{hr})(\text{°F})}{\text{Btu}} = \frac{(\text{m}^2)(\text{°K})}{\text{W}}$$

INSTALLATION

Floor protection must be non-combustible material extending beneath the stove, and to the front and sides from door opening and to rear as indicated.

The floor protection plate must lie under the stove and extend 16" (41cm) in front of the appliance. The floor protection plate must extend 0" to the back of the appliance. The floor protection plate must extend 8" to the sides of the stove. For installations with horizontal rear connector, the floor protection plate must extend under and 2" (50.8mm) to either side of the connector.

The floor protection plate must be listed to UL 1618, and is not required to have thermal protection (R=0).

Make sure that the floor and the sub-floor of the room in which the stove is installed is designed to carry the extra weight of the stove. The floor protector plate must be made of a non-combustible material.

When deciding where to install your stove, the heat distribution to other rooms should be taken into consideration. Put the stove at a safe distance from combustible materials; see the references at the name tag of the stove.

Thermal Floor Protection

Non-combustible ember protection with an R = 0 is required.

Size of floor protector.

width = 34"

Depth = 40"

Floor protector must be under the pipe and 2" (5cm) beyond each side for back venting.

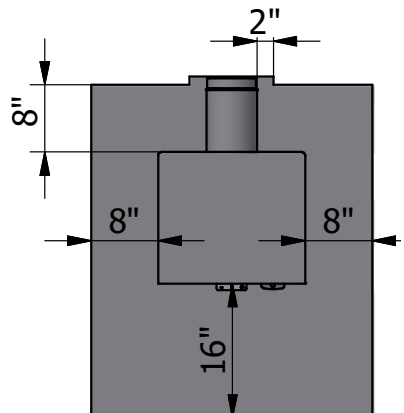

CLEARANCE TO COMBUSTIBLE WALLS

To find out whether the wall by which the stove is to be placed is combustible or not, please contact your architect or the local building authorities.

If the floor is combustible, the stove must be placed on a non-combustible plate such as steel, glass or stone.

It may be possible to reduce clearances to combustible walls using the methods detailed in NFPA 211. Seek guidance and permission in your locality as permits or inspections may be required.

Clearances may only be reduced by means approved by regulatory authority

** Rear / Top vent option Ceiling

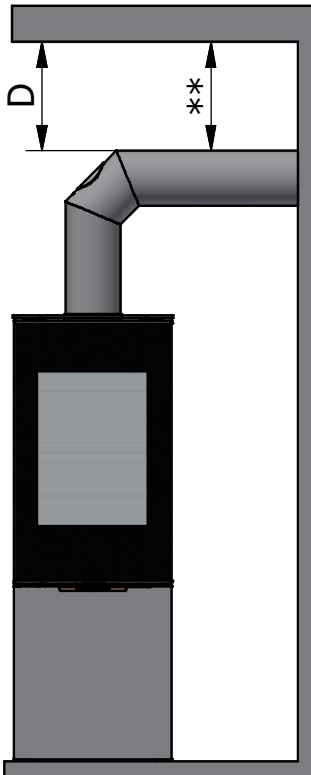

**.

Please refer to NFPA guidelines

INSTALLATION

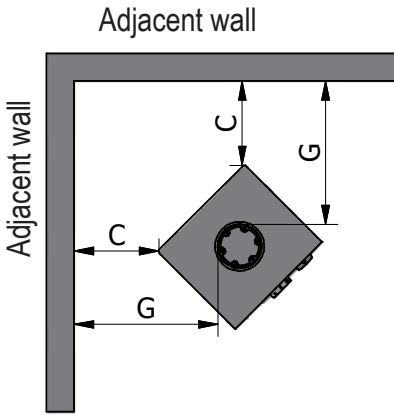
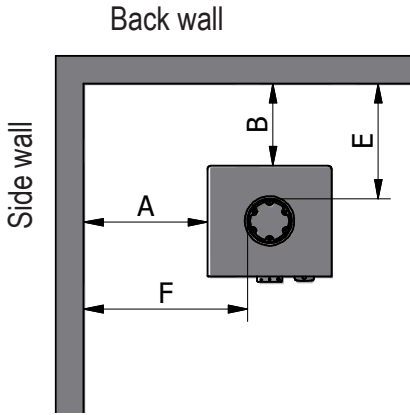

Minimum Clearance	Single Wall Vent Pipe	Double Wall Vent Pipe	With Swivel Base 10-0000-1501	Back Wall Flue Exit
A: Side Wall to Unit	20" / 508 mm	20" / 508 mm	36" / 915 mm	20" / 508 mm
B: Back Wall to Unit	9" / 229 mm	9" / 229 mm	36" / 915 mm	10" / 254 mm
C: Corner Wall to Unit	11" / 279 mm	11" / 279 mm	36" / 915 mm	11" / 279 mm
D: Ceiling from Vent Pipe	56" / 1422 mm	56" / 1422 mm	56" / 1422 mm	56" / 1422 mm
E: Back Wall to Vent Pipe	13.7" / 349 mm	13.7" / 349 mm	40.7" / 1034 mm	14.7" / 374 mm
F: Side Wall to Vent Pipe	25.7" / 653 mm	25.7" / 653 mm	41.7" / 1059 mm	25.7" / 653 mm
G: Corner Wall to Vent Pipe	19.2" / 486 mm	19.2" / 486 mm	44.2" / 1123 mm	19.2" / 486 mm

CLEARANCE TO NON-COMBUSTIBLE WALL

We recommend a minimum clearance to non-combustible material of at least 2" (50 mm) so that cleaning is easy. The cleaning door of the chimney should be accessible at all times.

Clearances may only be reduced by means approved by the regulatory authority.

VENTILATION

Extractor fans may not be fitted in the same room as the stove, as this can cause the stove to emit smoke and fumes into the room.

The stove requires a permanent and adequate air supply to operate safely and effectively. The installer may have fitted a permanent air supply vent into the room in which the stove is installed to provide combustion air.

This air vent should not be shut off or sealed under any circumstances.

INSTALLATION OF SWIVEL BASE

Please note, that when using a swivel base the clearances to side and backwall have special clearances, see table on page 35.

The stove is available with or without a swivel base. If the stove is delivered with a swivel base, the swivel base is mounted under the stove. The upper and lower part are held together and locked with 2 transport screws (thumbscrews). After the stove is installed, remove the transport screws to free the swivel base.

Remove the front cover, on the front side of the stove before installing, to access the swivel base. Mount the front cover again when done.

The swivel base can be installed:

- at 90 degrees (45 degrees on each side)
- (factory default setting)
- at 360 degrees

The swivel base lock (spring) can be tightened by loosening the screw to adjust the bracket. Move the bracket toward the plus symbol and tighten the screw again.

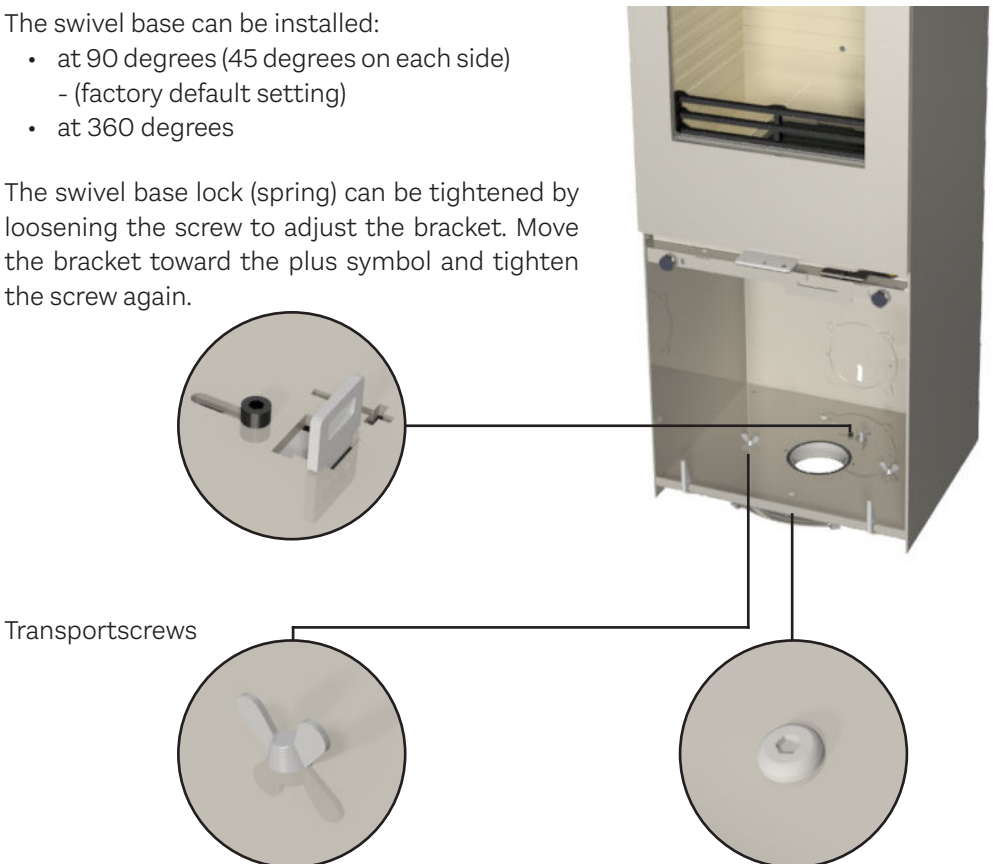

Transportscrews

Installing a 360° swivel base. Remove the stop screw. The stove can now rotate freely.

FIREWOOD

Only burn wood that has been seasoned for at least one full year (two years is better). If the wood has not been seasoned or dried, energy will be lost in evaporating the water held in the wood. Furthermore, condensation or creosote might occur in the stove and pipe when damp wood is burnt.

Freshly cut wood contains approx. 60-70% water and is completely unsuited for burning.

Log size should be about 2" (5 cm) less than the width of the firebox.

WARNING!



NEVER burn trash (plastic and other types of artificial materials emit harmful gases), driftwood, treated or painted wood, artificial logs or non-seasoned wood. NEVER burn fuels other than specified! Burning charcoal for example, contains the risk of generating carbon monoxide hazards!

All types of wood heat equally per pound; however, the density of wood is not the same as is shown in the table below, where the combustible value of wood dried for two years with a moisture of 15-20% is taken into account. See table to the left.

DRYING AND STORAGE

Wood to be used for burning in a stove should be dried for two years to ensure optimal burning.

Here are some storage tips:

- Cut and split the wood before storing.
- Keep the woodpile in a dry sunny place, protected from the rain. Do not cover the pile with plastic, because that prevents the wood from drying properly.
- Stack the wood with enough space between the rows to ensure good air circulation.
- Bring the logs inside the house two-three days prior to use.

Wood type	Dry wood kg/m ³	In comparison to beech
Beech and oak	580	100 %
Ash	570	98 %
Maple	540	93 %
Birch	510	88 %
Mountain pine	480	83 %
Fir	390	67 %
Poplar	380	65 %

DO NOT STORE SOLID FUEL WITHIN SPACE HEATER INSTALLATION CLEARANCES OR WITHIN THE SPACE REQUIRED FOR CHARGING AND ASH REMOVAL.

ADJUSTING THE COMBUSTION AIR

The appliance is equipped with an easy-to-use handle for adjusting the air control.

For the various positions of the control please see the following illustrations. To ensure proper combustion process it is very important to supply the correct quantity of air at the right time and place. The adjustment range made from factory may not be altered for increasing firing for any reason.

Primary air is defined as combustion air for burning the mass of wood and stimulates production of volatile gases.

Secondary air is used to burn off the gases at high temperatures (above 1,000°F/540°C) The warm secondary air runs along the glass, keeping it free of soot.

Tertiary air is supplied through the tertiary air channel in the back of the burning chamber and through the baffle plate above the burning chamber. Tertiary air helps to combust the remaining gases.

When positioning the air control between Pos. 2 and 3 optimum utilization of the energy contents of the wood is obtained, because of sufficient oxygen for combustion. When the flames burn bright and yellow, the control has been adjusted correctly. Finding the correct position takes some trial and error, but is easy to find.

Never close the air control completely before the flames are no longer visible. A typical error is to close the control too soon, because the heat gets too intense. This results in the appearance of a dark cloud of smoke from the chimney and that means the energy value of the wood is not being used properly.

It is important for proper control of the fire that the instructions in the manual are followed and the stove door normally is kept closed. It is also necessary to keep the seals in a good condition.



Only use wood as fuel as described in the firewood section of this manual.

WARNING!

Remember the stove is hot while in operation, so keep children, clothing, and furniture away. Contact with a stove when burning may cause skin burns.



WARNING!

Do NOT fire the stove with the door open!



Adjusting the air control

There are three different positions for air control:



Position 1:

Start up: Air damper is fully open. This position is only used during kindling and refueling.



Position 2:

Full Primary air: The handle is adjust to the click position in the middle. This position provides full primary air intake. During ordinary operation the handle is to be adjusted to the interval between pos. 2 and 3. When the flames are clear and yellow, the damper has been adjusted correctly resulting in slow/optimal combustion.



Position 3:

Fully closed: The handle is adjust all the way to the left. This position is used during the ember fase when the flames are no longer visible. This position still provides sufficient air for the remaining combustion fase.

CARBON MONOXIDE DETECTORS

Normal activity of loading fuel could result in emissions of smoke. It might be necessary to move carbon monoxide detectors, if they are triggered during normal useage of the stove.

CONTROL

If the ashes are white and the combustion chamber walls not covered with soot, the air adjustment has been correct and the wood sufficiently dry.

FIRST FIRE

Your new RAIS should be broken into gently for top performance and to prevent paint damage, cracks in the firebrick, and excessive wear and tear. Start with a small fire (never overload the firebox) to allow the materials to get accustomed to the higher temperatures, and then gradually increase the intensity.

For the first few fires you may detect a strange smell that comes from heat treating the paint and materials. This is normal and will soon disappear. Just ensure there is plenty of fresh air in the room. Furthermore, during the initial heating up and cooling down, the metal may emanate some clicking sounds due to being exposed to the large differences in temperature. This is normal as well.

For wood to burn properly, the right amount of air has to be supplied at the right time and place.

LIGHTING AND FUELLING - "Top-down" burning

Follow the instructions 1-5 below to properly ignite and use the stove.

NOTE!

If the air system is connected, the valve must remain open.



- ① Start by placing 12 pieces of split firewood in layers of 4 at the bottom of the stove. Place kindling bags between layers 2 and 3 as shown in the picture. The kindling should measure about 4x3x23 cm - it weighs about 1.5 kg in total.



2 pcs kindling bags

- ② After positioning the air damper to the open position, place the two remaining sticks. Light the two kindling bags that are positioned in between the layers to start the fire. Till the fire has a firm hold on the sticks, keep the door slightly open.

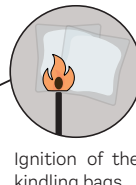
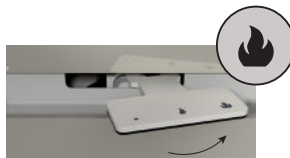

USING THE STOVE

- ③ When the fire has a firm grip on the sticks, close the door fully and adjust the air damper to the middle position.

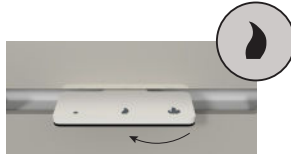

- ④ When the last flames have burned down and there is a nice layer of embers, add two to three pieces of wood weighing 1.5 kg in total. Keep the door slightly open until the flames have growth.



- ⑤ When the flames have taken grip, close the door completely. After 5 minutes - or when there are clear yellow flames - gradually close the damper.

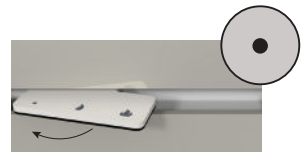
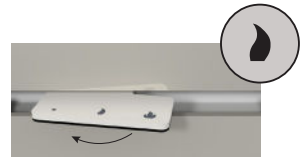

FUEL CAUTION



WARNING!

Do **NOT** burn garbage or flammable fluids such as gasoline, naphtha, or engine oil (plastic and other artificial materials emit harmful gases), driftwood, treated wood, artificial logs, or non-seasoned wood.

Do **NOT** use chemicals or fluids to start the fire.

Never use gasoline, gasoline-type lantern fuel, kerosene, charcoal lighter fluid, or similar liquids to start or 'freshen up' a fire in this heater. Keep all such liquids well away from the heater while it is in use.

MAINTAINING THE INSTALLATION

Establish a routine for the fuel, wood burner and firing technique. Check daily for creosote build-up until experience shows how often you need to clean to be safe. Be aware that the hotter the fire the less creosote is deposited, and weekly cleaning may be necessary in mild weather even though monthly cleaning may be enough in the coldest months. Contact your local municipal or provincial fire authority for information on how to handle a chimney fire. Have a clearly understood plan to handle a chimney fire.

CARE AND MAINTENANCE

You should have your chimney, stove and connector pipe checked once every two months during the heating season or at least once a year by a professional chimney sweep and cleaned as needed.

When cleaning the stove carefully inspect the seals for damage. The seals should be in good conditions and without damage.

When cleaning, checking or repairing, the stove must be cold.

If the glass has been covered in soot, here is a simple piece of advice:

- Dampen a piece of paper or newspaper, dip it into the cold ashes and rub the soot-covered glass.
- Use another piece of paper to polish the glass.
- A good commercial glass cleaner can also be used.
- Do not use abrasive cleaners.

The outer surfaces can be wiped with a soft, dry rag and if needed a small amount of mild detergent. NEVER scrub the surfaces.

Cleaning the soapstone:

Day-to-day cleaning can be made with a damp rag. If necessary the soapstone can be carefully cleaned with some paint-thinner from the hardware store. For difficult stains that cannot be dissolved by the paint-thinner, lightly sand them.

Cleaning the combustion chamber:

Rake out the ashes and store them in a metal container with a tight-fitting lid until cooled completely before throwing them in the trash can. Other waste shall not be placed in this container.

Remember NEVER to clean all ashes from the combustion chamber. Leave about a 3/4" layer for better combustion.

REMOVING THE COMBUSTION CHAMBER LINING

The combustion chamber lining protects the body of the appliance from the heat of the fire. The large differences in temperature can lead to cracks in the combustion chamber lining. This will not affect the functionality of the appliance. The lining will only need to be replaced after several years of use when it begins to disintegrate. The liner panels are easy to place in position and can easily be replaced by you or your dealer.

Procedure for removing the combustion chamber lining:

1. Remove the smoke deflector plate (1) by pulling it forward and tilting it so that it is free of the vertical plates. The smoke deflector can now be carefully removed.
2. Remove the base plates (2).
3. Loosen the side plates (3) by turning the front end of the plate towards the center of the stove. Then take them out carefully.
4. Remove the back plates (4) by pulling the side of the plates forward and out.
5. How to remove the upper baffle plate can be seen on the following pages.

When the combustion chamber liner is to be reassembled, do so in reverse order.

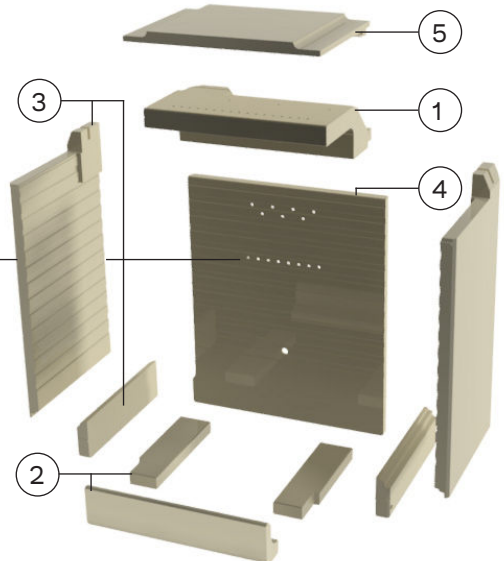

MAX LOAD

The maximum allowable amount of firewood is marked with a series of holes in the back plates. This means that firewood may only be filled up to this row of holes.

LUBRICATING THE HINGES & LOCK

The appliance must be lubricated regularly at the moving parts on the door and locking mechanism (see image). Use heat-resistant oil.



CLEANING THE SMOKE / BAFFLE SYSTEM

Remove the Baffle plate, by pushing it up, pulling it forward, and then lower the back part.

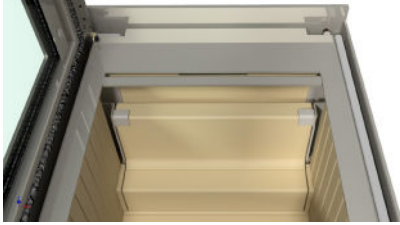

Pushing it up and pulling it forward



Then lower the back part



Remove the Baffle plate

Remove the Upper baffle plate by moving the plate up and to the left, then lower the right side and take the plate out of the appliance.



Moving the plate up and to the left



Take the plate out

Remove the Ash stopper, by lifting it upwards.



CREOSOTE - FORMATION AND NEED FOR REMOVAL

When wood is burned slowly, it produces tar and other organic vapors, which combine with expelled moisture to form creosote. The creosote vapors condense in the relatively cool chimney flue of a slow-burning fire. As a result, creosote residue accumulates on the flue lining.



WARNING!

When ignited, this creosote makes an extremely hot fire. The chimney and chimney connector should be inspected at least once every two months during the heating season to determine if a creosote buildup has occurred. If creosote has accumulated, it should be removed to reduce the risk of a chimney fire.

DISPOSAL OF ASHES

The firebox lining is made out of vermiculite slab insulation (skamol), which protects the outer steel plates from overheating. With time small cracks might appear; this is normal. If it breaks however, it must be replaced. Vermiculite is a porous, high-insulated material and must therefore be handled with care.



NOTE!

Ashes should be placed in a metal container with a tightfitting lid. The closed container of ashes should be placed on a noncombustible floor or on the ground, well away from all combustible materials, pending final disposal. If the ashes are disposed of by burial in soil or otherwise locally dispersed, they should be retained in the closed container until all embers have thoroughly cooled. Other waste shall not be placed in this container.

TROUBLE SHOOTING

Smoke seeping through the door:

- Not enough draft in the chimney (<12 Pa)
- Check if there are any obstructions in the chimney or the wind pipe
- Check whether the kitchen exhaust fan is in use and if so, turn it off and open the window for a short period of time

Soot on the glass:

- The wood is too damp
- Make sure that the stove is sufficiently heated up before closing the door
- The air control has been set too low

The stove burns too quickly:

- Gasket may not be tight, please check and replace if necessary
- Chimney draft maybe too high >22 Pa, if this is the case, please install a damper

The stove is burning too slowly:

- Not sufficient amount of firewood
- Not enough air is getting into the stove
- Blocked chimney
- Leaking chimney
- Leak between chimney and pipe

If the problems continue we recommend contacting your chimney sweep or your local RAIS dealer.

Chimney fire, soot fire or creosote fire:

In case of a fire in the chimney quickly close all doors, dampers, vents and call your local fire department. **NEVER** use water to extinguish the fire.

SPARE PARTS DRAWING

NEXO 100/120/140/160/185 USA
 (models without sideglasses)

NEXO 100/120/140/160/185 G USA
 (models with sideglasses)

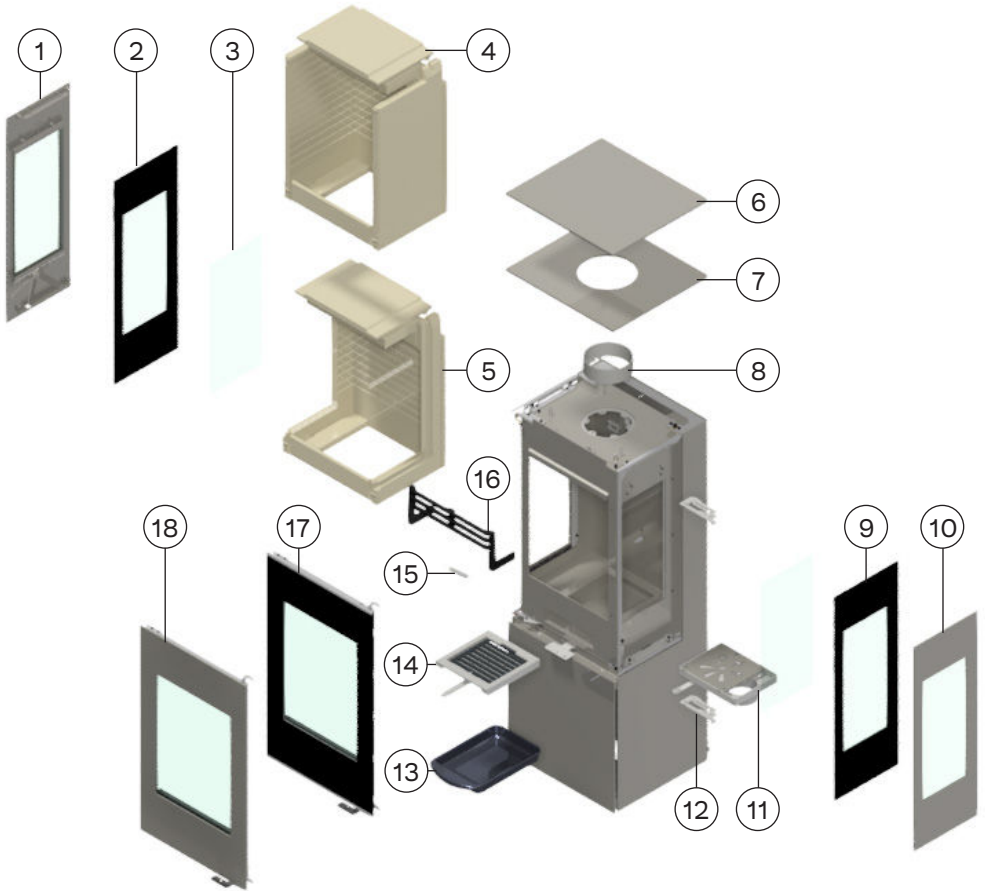

SPARE PARTS

NEXO 100/120/140/160/185 USA **NEXO 100/120/140/160/185 G USA**

Only use the specified original Rais components! If spare parts other than those recommended by RAIS are used, the warranty is voided.

All replaceable parts can be bought as spare parts from your RAIS distributor.
For reference see spare parts drawing (front of the user manual).

(XX: optional color code)

Ref. no.	Quantity	Part no.	Description
1	1	10-0000-2601xx	Side panel Classic left
2	1	10-0000-5003	Outher side glass Left
3	2	10-0000-5005	Inner glass for body
4	1	10-0000-2210-USA	Skamol set for USA
5	1	10-0000-2209-USA	Skamol set for USA, Sideglass version
6	1	10-0000-0601xx	Top plate for back outlet
7	1	10-0000-0602xx	Top plate for top outlet
8	1	61-110	Flue collar for USA-England
9	1	10-0000-5504	Outher side glass Right
10	1	10-0000-2602xx	Side panel Classic right
11	1	10-0000-0904USA	Airdamper
12	2	10-0000-180502	Closing mechanism
13	1	1314001	Ash pan
14	1	1313801	Shaking grate
15	2	7301026	Ba 1 spring
16	1	10-0000-1301SORT	Ash stop
17	1	10-0000-1006	Glass door with double glass
18	1	10-0000-1008xx	Classic glass door with double glass
19	1	10-0000-5502	Seal set for glass door
20	1	10-0000-5504	Seal set for Classic Door Double glass
21	1	10-0000-5505	Seal set for Side glass

FRESH AIR SUPPLY, AIR THROUGH THE BACK

When the space heater is installed in a structure where direct combustion air is required, an air kit must be used to supply fresh air to the appliance from outside.

1. Remove the air inlet cover form on the back of the appliance.
2. Mount the flex hose (4) to the air valve (3) with the hose clamp (1)
3. Mount the air valve (3) on the wall, over the hole leading to the outside.
4. Connect the flex tube (4) to the airbox using a hose clamp (1).

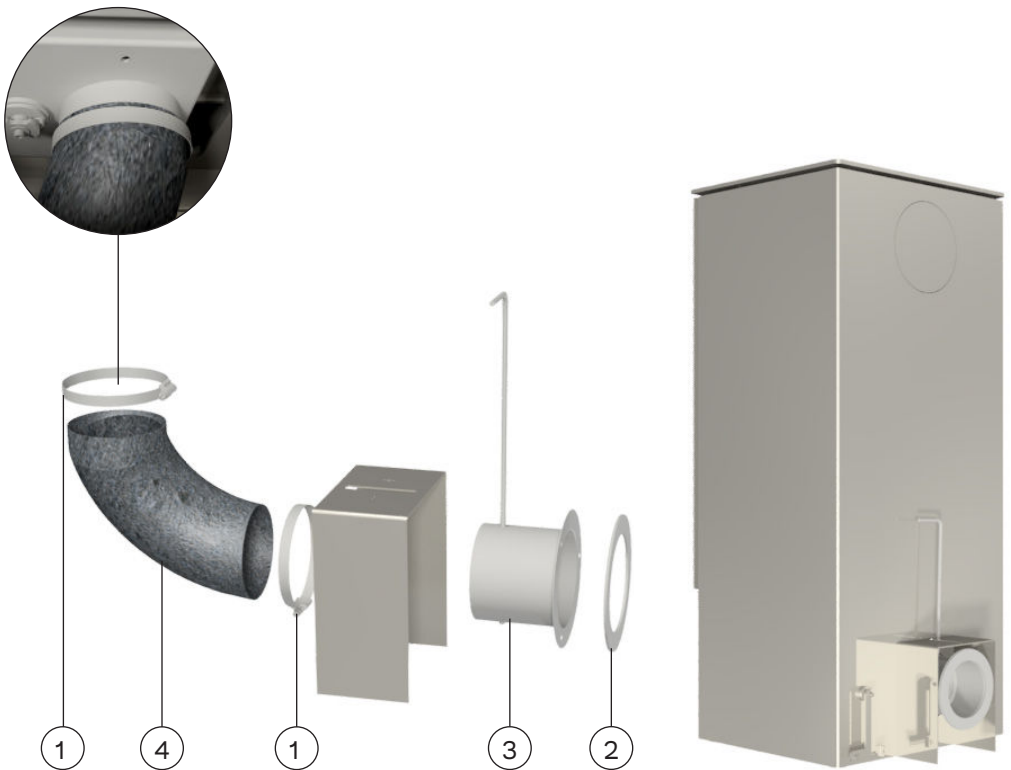

FRESH AIR SUPPLY, AIR THROUGH THE BOTTOM

When the space heater is installed in a structure where direct combustion air is required, an air kit must be used to supply fresh air to the appliance from outside.

1. Place the foam ring (5) over the air inlet hole in below the appliance. Remove the knock-out form in the bottom plate. Place the appliance centered over the same hole.

2. Remove the front cover by pulling it outwards.

3. Place the seal (2) around the hole from the knock-out form. Place the air valve (3) on the seal (2), make sure the handle is placed like on the pic.

4. Mount the air hose (4) to the airbox and the air nozzle (3) using the hose clamp (1)

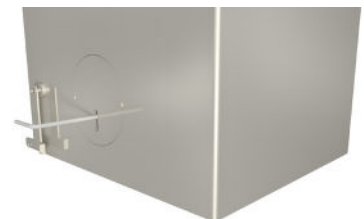

Handle on the back



RAIS[®]
ART  OF FIRE

RAIS A/S
Industrivej 20
DK-9900 Frederikshavn
Denmark
www.rais.com

